

Specification:

1. Connector Type : LC/PC Multimode
2. Connector Type : ST/PC Multimode
3. Cable Type :  
Zipcord cable,  $\phi 3.0\text{mm}$ , 62.5/125um Multimode,  
Cable Jacket : Orange color, PVC material
4. Length : xM
5. Cable Marker
6. Shrink Tube

Performance:

- a. Insertion Loss :  $< 0.5 \text{ dB}$
- b. Fiber Extension :  $-0.05\mu\text{m} < H < +0.05\mu\text{m}$
- c. Ferrule End-face Radius :  $10 < R < 30\text{mm}$
- d. Apex Offset :  $< 50\mu\text{m}$
- e. Increase in insertion loss after 500 mating :  $0.2 \text{ dB Max.}$
- f. Operation Temperature :  $-20^\circ \text{ to } +70^\circ$
- g. Storage Temperature :  $-40^\circ \text{ to } +80^\circ$
- h. Humidity (non-condensing) 95%RH

**BELKIN®**

BELKIN CORPORATION  
501 West Walnut Street, Compton, CA 90220-5221, USA  
TEL: 310-898-1100; FAX: 310-898-1111  
www.belkin.com

PART NO.: F2F202L0

DES.: ST to LC Duplex patch cord

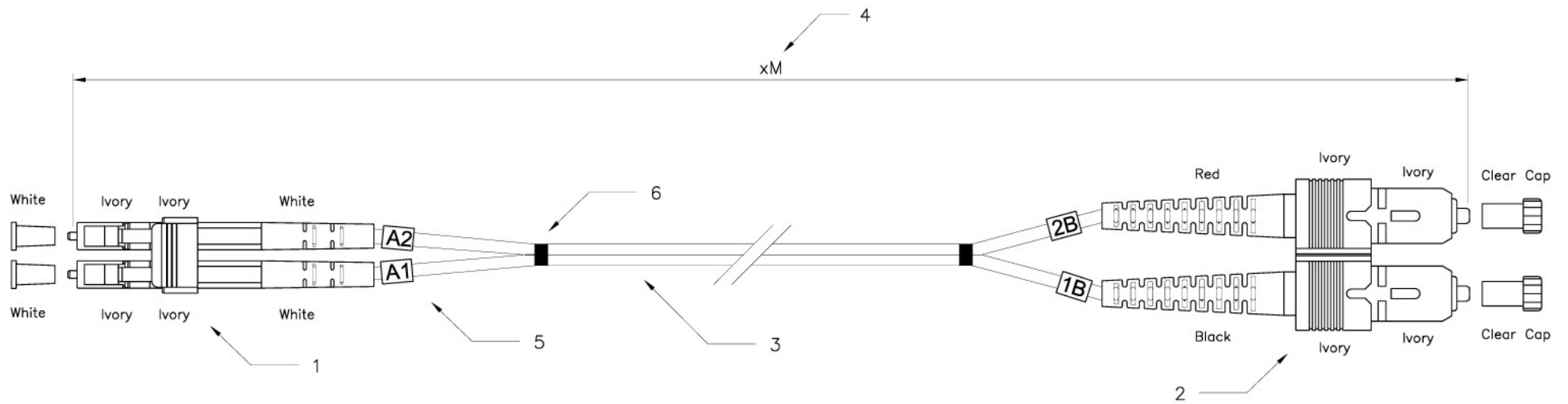

Specification:

1. Connector Type : LC/PC Multimode
2. Connector Type : SC/PC Multimode
3. Cable Type :  
Zipcord cable,  $\phi 3.0\text{mm}$ , 62.5/125um Multimode,  
Calbe Jacket : Orange color, PVC material
4. Length : xM
5. Cable Marker
6. Shrink Tube

Performance:

- a. Insertion Loss :  $< 0.5 \text{ dB}$
- b. Fiber Extention :  $-0.05\mu\text{m} < H < +0.05\mu\text{m}$
- c. Ferrule End-face Radius :  $10 < R < 30\text{mm}$
- d. Apex Offset :  $< 50\mu\text{m}$
- e. Increase in insertion loss after 500 mating :  $0.2 \text{ dB Max.}$
- f. Operation Temperature :  $-20^\circ \text{ to } +70^\circ$
- g. Storage Temperature :  $-40^\circ \text{ to } +80^\circ$
- h. Humidity (non-condensing) 95%RH

**BELKIN®**

BELKIN CORPORATION  
 501 West Walnut Street, Compton, CA 90220-5221, USA  
 TEL: 310-898-1100; FAX: 310-898-1111  
 www.belkin.com

---

PART NO.: F2F202L7

---

DES.: SC to LC Duplex patch cord

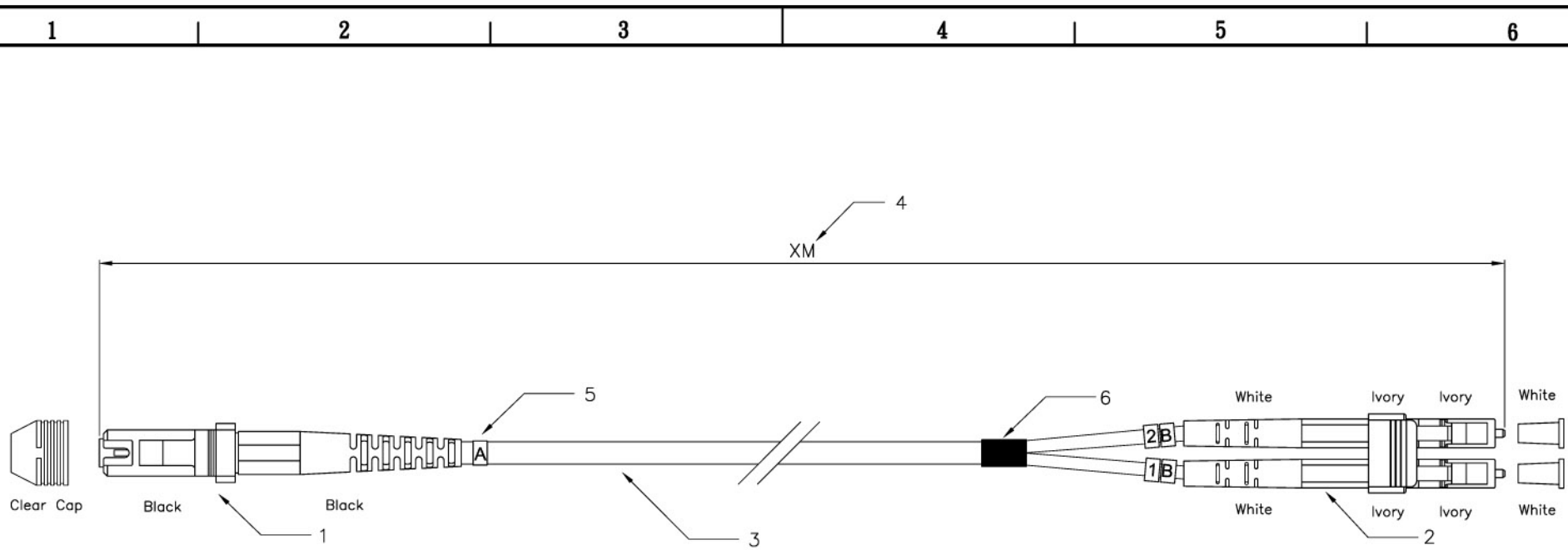

Specification:

1. Connector Type : MT-RJ Multimode
2. Connector Type : LC/PC Multimode
3. Cable Type :  
Duallan cable,  $\phi 3.0\text{mm}$ , 62.5/125um Multimode,  
Calbe Jacket : Orange color, PVC material
4. Length : XM
5. Cable Marker
6. Shrink Tube

Performance:

- a. Insertion Loss :  $< 0.5 \text{ dB}$
- b. Fiber Extention :  $-0.05\mu\text{m} < H < +0.05\mu\text{m}$
- c. Ferrule End-face Radius :  $10 < R < 30\text{mm}$
- d. Apex Offset :  $< 50\mu\text{m}$
- e. Increase in insertion loss after 500 mating :  $0.2 \text{ dB Max}$
- f. Operation Temperature :  $-20^\circ \text{ to } +70^\circ$
- g. Storage Temperature :  $-40^\circ \text{ to } +80^\circ$
- h. Humidity (non-condensing) 95%RH

**BELKIN®**

BELKIN CORPORATION  
501 West Walnut Street, Compton, CA 90220-5221, USA  
TEL: 310-898-1100; FAX: 310-898-1111  
www.belkin.com

PART NO.: F2F202L9

DES.: LC to MTRJ Duplex patch cord

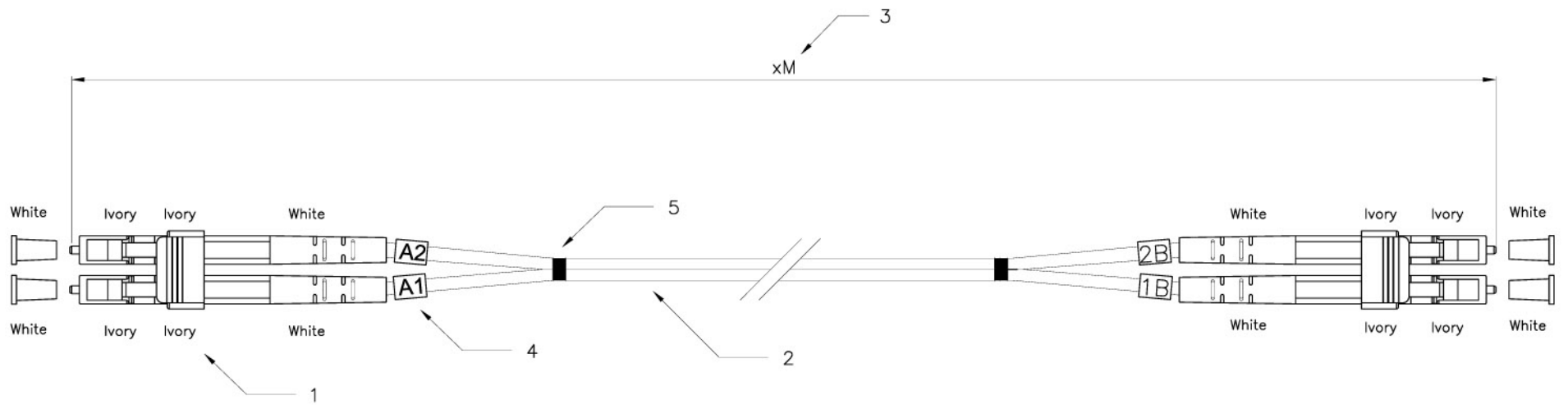

Specification:

- 1. Connector Type : LC/PC Multimode
- 2. Cable Type :  
Zipcord cable,  $\varnothing 3.0\text{mm}$ , 62.5/125um Multimode,  
Calbe Jacket : Orange color, PVC material
- 3. Length : xM
- 4. Cable Marker
- 5. Shrink Tube

Performance:

- a. Insertion Loss :  $< 0.5 \text{ dB}$
- b. Fiber Extention :  $-0.05\mu\text{m} < H < +0.05\mu\text{m}$
- c. Ferrule End-face Radius :  $10 < R < 30\text{mm}$
- d. Apex Offset :  $< 50\mu\text{m}$
- e. Increase in insertion loss after 500 mating :  $0.2 \text{ dB Max.}$
- f. Operation Temperature :  $-20^\circ \text{ to } +70^\circ$
- g. Storage Temperature :  $-40^\circ \text{ to } +80^\circ$
- h. Humidity (non-condensing) 95%RH

**BELKIN®**

BELKIN CORPORATION  
 501 West Walnut Street, Compton, CA 90220-5221, USA  
 TEL: 310-898-1100; FAX: 310-898-1111  
 www.belkin.com

---

PART NO.: F2F202LL

---

DES.: LC to LC Duplex patch cord

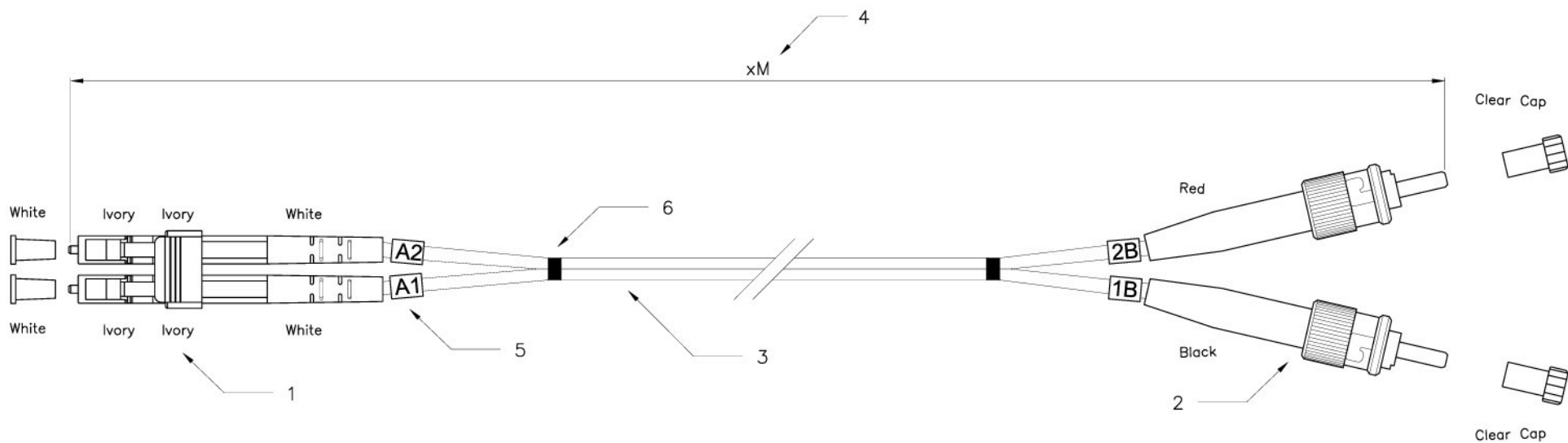

Specification:

1. Connector Type : LC/PC Multimode
2. Connector Type : ST/PC Multimode
3. Cable Type :  
Zipcord cable,  $\phi 3.0\text{mm}$ , 50/125um Multimode,  
Cable Jacket : Orange color, PVC material
4. Length : xM
5. Cable Marker
6. Shrink Tube

Performance:

- a. Insertion Loss :  $< 0.5 \text{ dB}$
- b. Fiber Extention :  $-0.05\mu\text{m} < H < +0.05\mu\text{m}$
- c. Ferrule End-face Radius :  $10 < R < 30\text{mm}$
- d. Apex Offset :  $< 50\mu\text{m}$
- e. Increase in insertion loss after 500 mating :  $0.2 \text{ dB Max.}$
- f. Operation Temperature :  $-20^\circ \text{ to } +70^\circ$
- g. Storage Temperature :  $-40^\circ \text{ to } +80^\circ$
- h. Humidity (non-condensing) 95%RH

**BELKIN®**

BELKIN CORPORATION  
501 West Walnut Street, Compton, CA 90220-5221, USA  
TEL: 310-898-1100; FAX: 310-898-1111  
www.belkin.com

PART NO.: F2F402L0

DES.: ST to LC Duplex patch cord

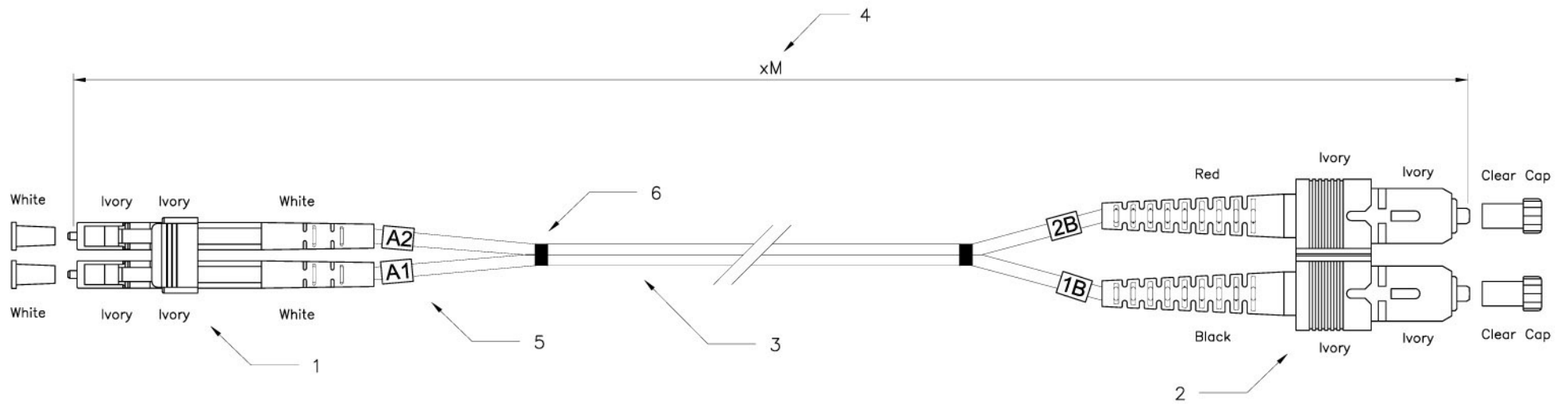

Specification:

1. Connector Type : LC/PC Multimode
2. Connector Type : SC/PC Multimode
3. Cable Type :  
Zipcord cable,  $\phi 3.0\text{mm}$ , 50/125um Multimode,  
Cable Jacket : Orange color, PVC material
4. Length : xM
5. Cable Marker
6. Shrink Tube

Performance:

- a. Insertion Loss :  $< 0.5 \text{ dB}$
- b. Fiber Extention :  $-0.05\mu\text{m} < H < +0.05\mu\text{m}$
- c. Ferrule End-face Radius :  $10 < R < 30\text{mm}$
- d. Apex Offset :  $< 50\mu\text{m}$
- e. Increase in insertion loss after 500 mating :  $0.2 \text{ dB Max.}$
- f. Operation Temperature :  $-20^\circ \text{ to } +70^\circ$
- g. Storage Temperature :  $-40^\circ \text{ to } +80^\circ$
- h. Humidity (non-condensing) 95%RH

**BELKIN®**

<p><b>BELKIN CORPORATION</b>          501 West Walnut Street, Compton, CA 90220-5221, USA          TEL: 310-898-1100; FAX: 310-898-1111          www.belkin.com</p>
PART NO.: F2F402L7
DES.: SC to LC Duplex patch cord

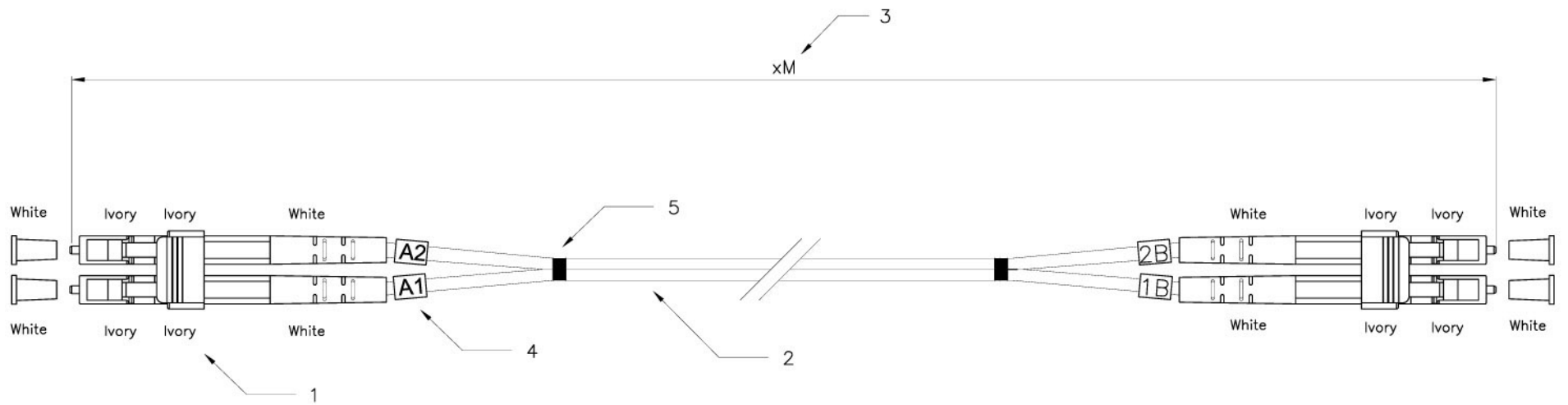

Specification:

- 1. Connector Type : LC/PC Multimode
- 2. Cable Type :  
Zipcord cable,  $\varnothing 3.0\text{mm}$ , 50/125um Multimode,  
Cable Jacket : Orange color, PVC material
- 3. Length : xM
- 4. Cable Marker
- 5. Shrink Tube

Performance:

- a. Insertion Loss :  $< 0.5 \text{ dB}$
- b. Fiber Extention :  $-0.05\mu\text{m} < H < +0.05\mu\text{m}$
- c. Ferrule End-face Radius :  $10 < R < 30\text{mm}$
- d. Apex Offset :  $< 50\mu\text{m}$
- e. Increase in insertion loss after 500 mating :  $0.2 \text{ dB Max.}$
- f. Operation Temperature :  $-20^\circ \text{ to } +70^\circ$
- g. Storage Temperature :  $-40^\circ \text{ to } +80^\circ$
- h. Humidity (non-condensing) 95%RH

**BELKIN®**

BELKIN CORPORATION  
 501 West Walnut Street, Compton, CA 90220-5221, USA  
 TEL: 310-898-1100; FAX: 310-898-1111  
 www.belkin.com

---

PART NO.: F2F402LL

---

DES.: LC to LC Duplex patch cord

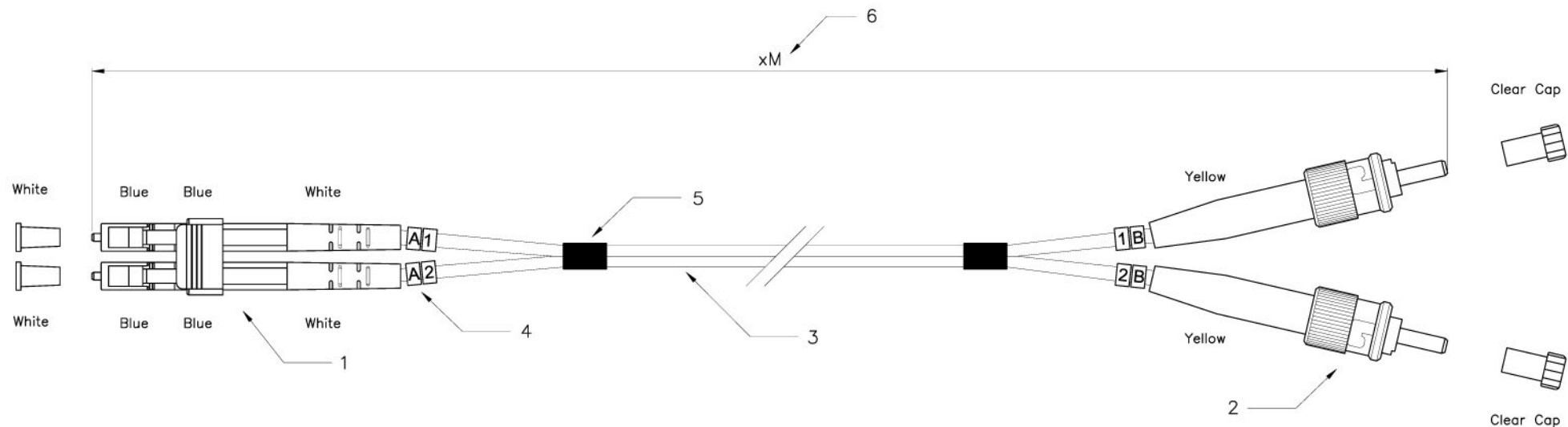

### Specification :

1. Connector Type : LC/PC Singlemode.
2. Connector Type : ST/PC Singlemode.
3. Cable Type :  
Zipcord cable,  $\varnothing 3.0\text{mm}$ , 8.3/125um Singlemode.  
Cable Jacket : Yellow color, PVC material.
4. Cable Marker.
5. Shrink Tube.
6. Length : xM.

### Performance :

- a. Insertion Loss :  $< 0.3 \text{ dB}$ .
- b. Return Loss :  $> 40 \text{ dB}$ .
- c. Fiber Extention :  $-0.05\mu\text{m} < H < +0.05\mu\text{m}$ .
- d. Ferrule End-face Radius :  $10 < R < 25\text{mm}$ .
- e. Apex Offset :  $< 50\mu\text{m}$ .
- f. Increase in insertion loss after 500 mating :  $0.2 \text{ dB Max}$ .
- g. Operation Temperature :  $-20^{\circ}\text{C}$  to  $+70^{\circ}\text{C}$ .
- h. Storage Temperature :  $-40^{\circ}\text{C}$  to  $+80^{\circ}\text{C}$ .
- i. Humidity (non-condensing) 95%RH.

# BELKIN®

BELKIN CORPORATION  
501 West Walnut Street, Compton, CA 90220-5221, USA  
TEL: 310-898-1100; FAX: 310-898-1111  
www.belkin.com

PART NO.: F2F802L0

DES.: ST to LC Duplex patch cord

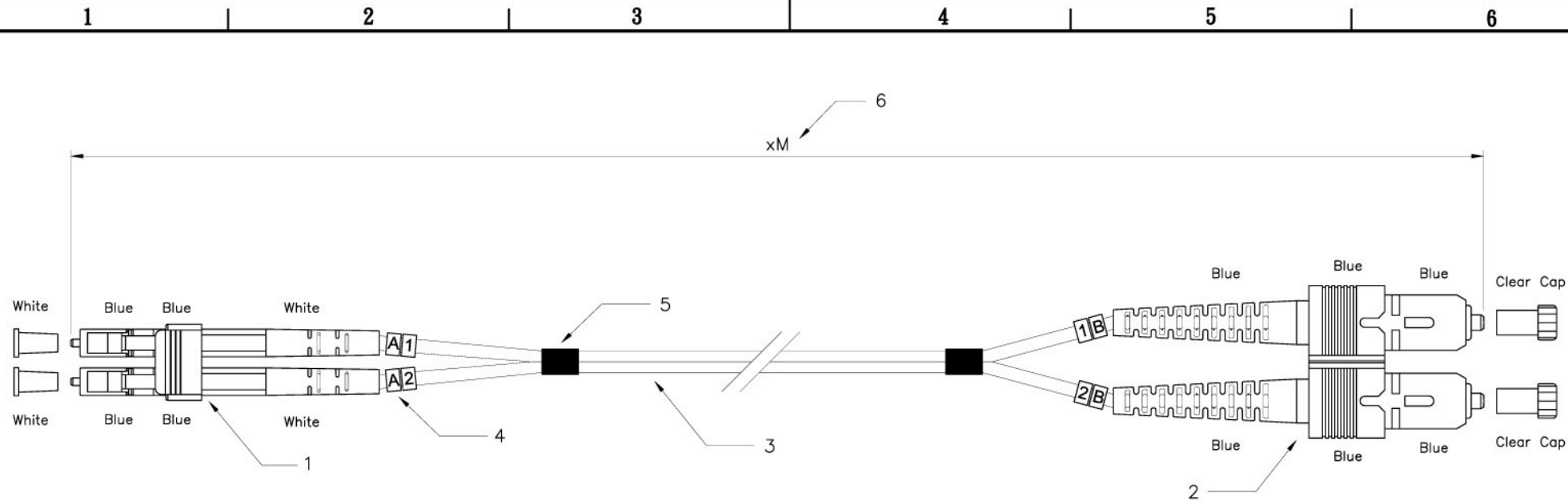

### Specification :

1. Connector Type : LC/PC Singlemode.
2. Connector Type : SC/PC Singlemode.
3. Cable Type :  
Zipcord cable,  $\varnothing 3.0\text{mm}$ ,  $8.3/125\mu\text{m}$  Singlemode.  
Cable Jacket : Yellow color, PVC material.
4. Cable Marker.
5. Shrink Tube.
6. Length : xM.

### Performance :

- a. Insertion Loss :  $< 0.3 \text{ dB}$ .
- b. Return Loss :  $> 40 \text{ dB}$ .
- c. Fiber Extention :  $-0.05\mu\text{m} < H < +0.05\mu\text{m}$ .
- d. Ferrule End-face Radius :  $10 < R < 25\text{mm}$ .
- e. Apex Offset :  $< 50\mu\text{m}$ .
- f. Increase in insertion loss after 500 mating :  $0.2 \text{ dB Max.}$
- g. Operation Temperature :  $-20^{\circ}\text{C}$  to  $+70^{\circ}\text{C}$ .
- h. Storage Temperature :  $-40^{\circ}\text{C}$  to  $+80^{\circ}\text{C}$ .
- i. Humidity (non-condensing)  $95\% \text{RH}$ .

# BELKIN®

BELKIN CORPORATION  
501 West Walnut Street, Compton, CA 90220-5221, USA  
TEL: 310-898-1100; FAX: 310-898-1111  
www.belkin.com

PART NO.: F2F802L7

DES.: SC to LC Duplex patch cord

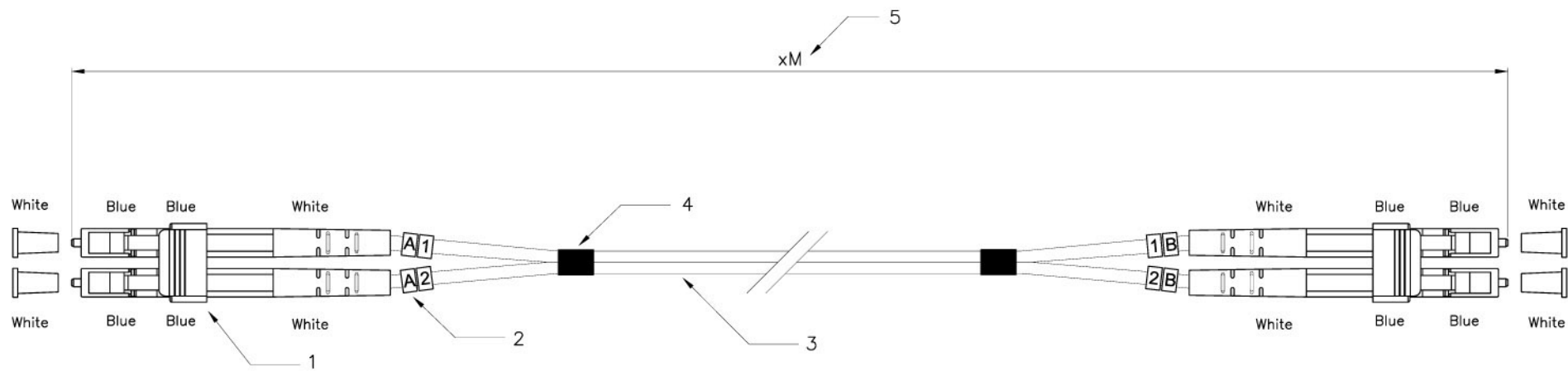

Specification :

1. Connector Type : LC/PC Singlemode.
2. Cable Marker.
3. Cable Type :  
Zipcord cable,  $\varnothing 3.0\text{mm}$ ,  $8.3/125\mu\text{m}$  Singlemode.  
Cable Jacket : Yellow color, PVC material.
4. Shrink Tube.
5. Length : xM.

Performance :

- a. Insertion Loss :  $< 0.3 \text{ dB}$ .
- b. Return Loss :  $> 40 \text{ dB}$ .
- c. Fiber Extention :  $-0.05\mu\text{m} < H < +0.05\mu\text{m}$ .
- d. Ferrule End-face Radius :  $10 < R < 25\text{mm}$ .
- e. Apex Offset :  $< 50\mu\text{m}$ .
- f. Increase in insertion loss after 500 mating :  $0.2 \text{ dB Max}$ .
- g. Operation Temperature :  $-20^{\circ}\text{C}$  to  $+70^{\circ}\text{C}$ .
- h. Storage Temperature :  $-40^{\circ}\text{C}$  to  $+80^{\circ}\text{C}$ .
- i. Humidity (non-condensing)  $95\% \text{RH}$ .

**BELKIN®**

BELKIN CORPORATION  
501 West Walnut Street, Compton, CA 90220-5221, USA  
TEL: 310-898-1100; FAX: 310-898-1111  
www.belkin.com

PART NO.: F2F802LL

DES.: LC to LC Duplex patch cord

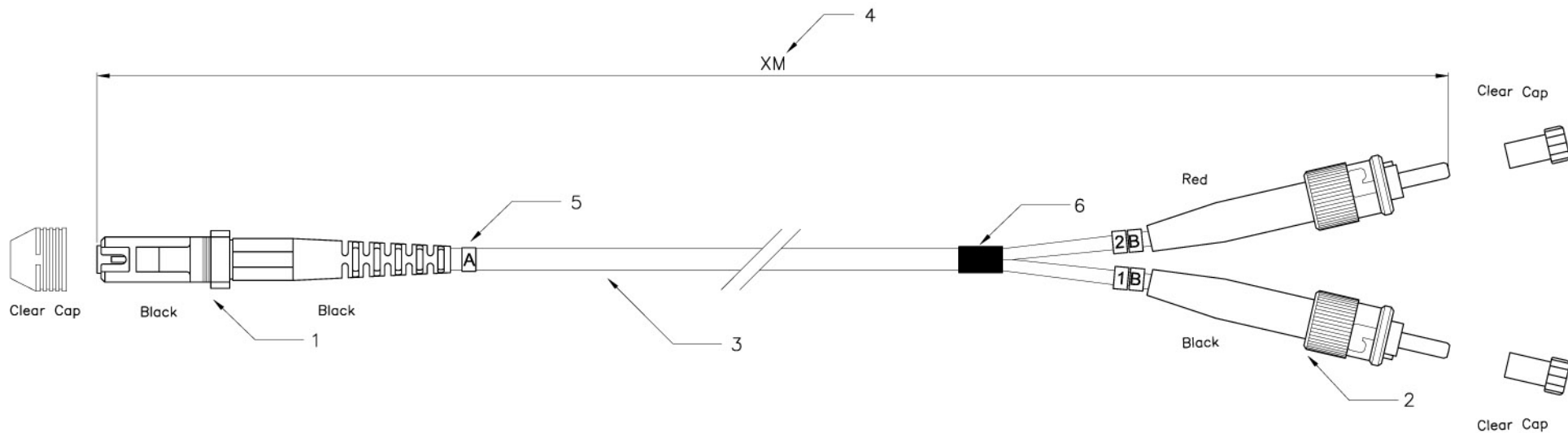

Specification:

1. Connector Type : MT-RJ Multimode
2. Connector Type : ST/PC Multimode
3. Cable Type :  
Duallan cable,  $\phi 3.0\text{mm}$ , 62.5/125um Multimode,  
Cable Jacket : Orange color, PVC material
4. Length : XM
5. Cable Marker
6. Shrink Tube

Performance:

- a. Insertion Loss :  $< 0.5 \text{ dB}$
- b. Fiber Extention :  $-0.05\mu\text{m} < H < +0.05\mu\text{m}$
- c. Ferrule End-face Radius :  $10 < R < 30\text{mm}$
- d. Apex Offset :  $< 50\mu\text{m}$
- e. Increase in insertion loss after 500 mating :  $0.2 \text{ dB Max}$
- f. Operation Temperature :  $-20^\circ \text{ to } +70^\circ$
- g. Storage Temperature :  $-40^\circ \text{ to } +80^\circ$
- h. Humidity (non-condensing) 95%RH

**BELKIN®**

BELKIN CORPORATION  
 501 West Walnut Street, Compton, CA 90220-5221, USA  
 TEL: 310-898-1100; FAX: 310-898-1111  
 www.belkin.com

---

PART NO.: F2F20290

---

DES.: ST to MTRJ Duplex patch cord

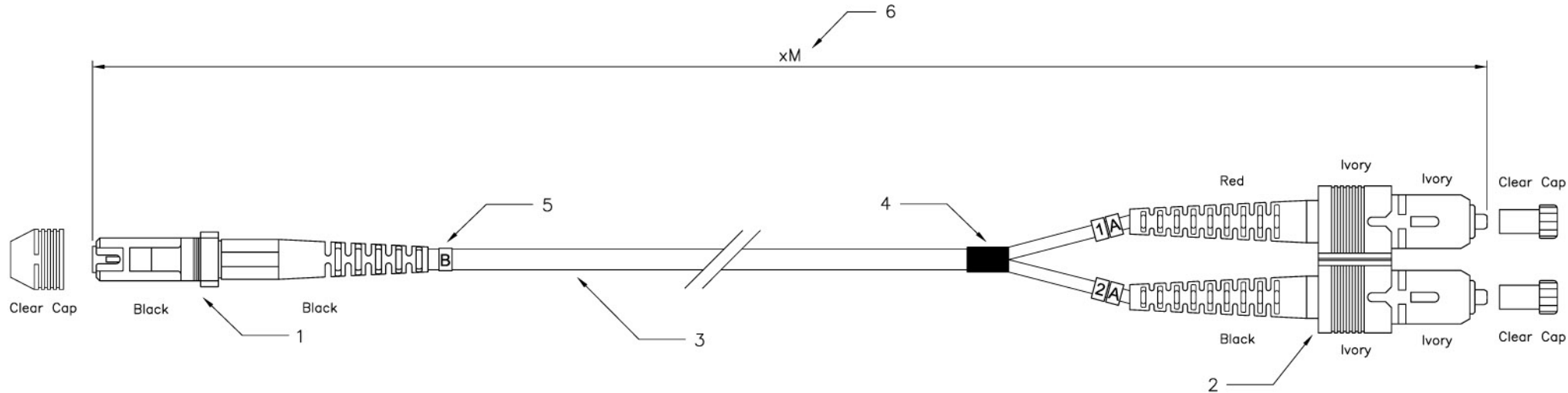

Specification:

1. Connector Type : MT-RJ Multimode.
2. Connector Type : SC/PC Multimode.
3. Cable Type :  
Duplex cable,  $\varnothing 3.0\text{mm}$ , 62.5/125um Multimode.  
Cable Jacket : Orange color, PVC material.
4. Cable Marker.
5. Shrink Tube.
6. Length : xM.

Performance:

- a. Insertion Loss :  $< 0.5$  dB.
- b. Fiber Extention :  $-0.05\mu\text{m} < H < +0.05\mu\text{m}$ .
- c. Ferrule End-face Radius :  $10 < R < 25\text{mm}$ .
- d. Apex Offset :  $< 50\mu\text{m}$ .
- e. Increase in insertion loss after 500 mating : 0.2 dB Max.
- f. Operation Temperature :  $-20^{\circ}\text{C}$  to  $+70^{\circ}\text{C}$ .
- g. Storage Temperature :  $-40^{\circ}\text{C}$  to  $+80^{\circ}\text{C}$ .
- h. Humidity (non-condensing) 95%RH.

**BELKIN®**

BELKIN CORPORATION  
501 West Walnut Street, Compton, CA 90220-5221, USA  
TEL: 310-898-1100; FAX: 310-898-1111  
www.belkin.com

PART NO.: F2F20297

DES.: SC to MT-RJ Duplex patch cord

1 2 3 4 5 6

A

A

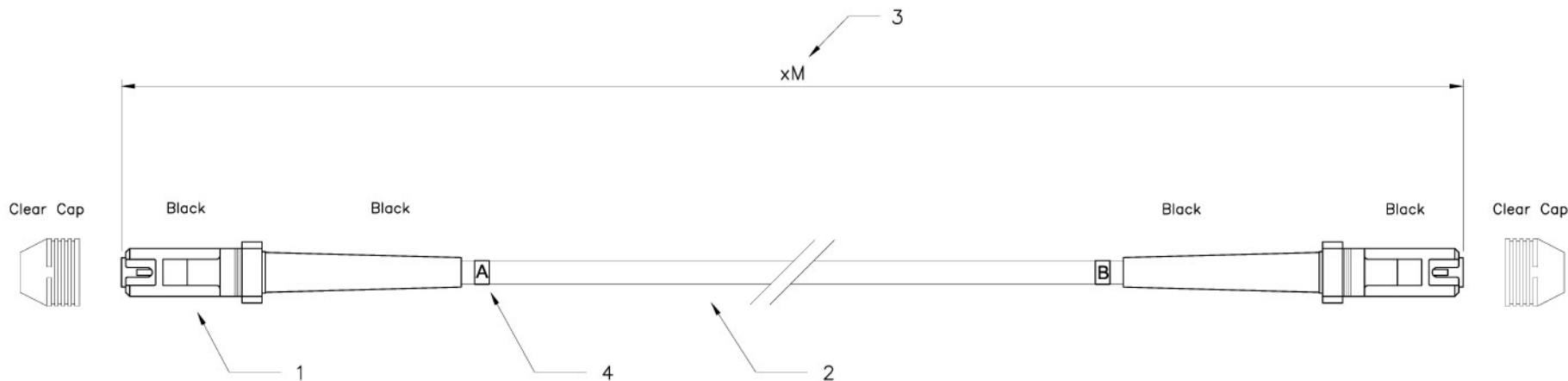

### Specification:

1. Connector Type : MT/RJ Multimode
2. Cable Type :  
Duallan cable,  $\phi 3.0\text{mm}$ , 62.5/125um Multimode,  
Calbe Jacket : Orange color, PVC material
3. Length : xM
4. Cable Marker

### Performance:

- a. Insertion Loss :  $< 0.5 \text{ dB}$
- b. Fiber Extension :  $-0.05\mu\text{m} < H < +0.05\mu\text{m}$
- c. Ferrule End-face Radius :  $10 < R < 30\text{mm}$
- d. Apex Offset :  $< 50\mu\text{m}$
- e. Increase in insertion loss after 500 mating :  $0.2 \text{ dB Max.}$
- f. Operation Temperature :  $-20^{\circ}\text{C}$  to  $+70^{\circ}\text{C}$
- g. Storage Temperature :  $-40^{\circ}\text{C}$  to  $+80^{\circ}\text{C}$
- h. Humidity (non-condensing) 95%RH

# BELKIN®

BELKIN CORPORATION  
 501 West Walnut Street, Compton, CA 90220-5221, USA  
 TEL: 310-898-1100; FAX: 310-898-1111  
 www.belkin.com

PART NO.: F2F20299

DES.: MT/RJ Duallan patch cord

1 2 0 3 4 10cm 5 6

D

D

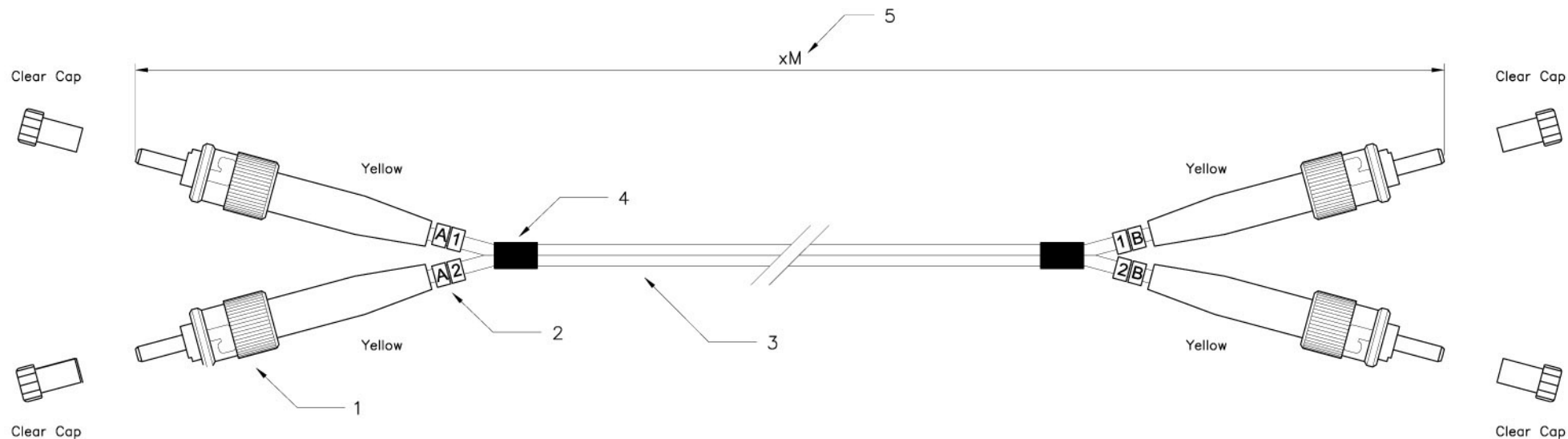

Specification :

1. Connector Type : ST/PC Singlemode.
2. Cable Marker.
3. Cable Type :  
Zipcord cable,  $\varnothing 3.0\text{mm}$ ,  $8.3/125\mu\text{m}$  Singlemode.  
Cable Jacket : Yellow color, PVC material.
4. Shrink Tube.
5. Length : xM.

Performance :

- a. Insertion Loss :  $< 0.3 \text{ dB}$ .
- b. Return Loss :  $> 40 \text{ dB}$ .
- c. Fiber Extention :  $-0.05\mu\text{m} < H < +0.05\mu\text{m}$ .
- d. Ferrule End-face Radius :  $10 < R < 25\text{mm}$ .
- e. Apex Offset :  $< 50\mu\text{m}$ .
- f. Increase in insertion loss after 500 mating :  $0.2 \text{ dB Max}$ .
- g. Operation Temperature :  $-20^{\circ}\text{C}$  to  $+70^{\circ}\text{C}$ .
- h. Storage Temperature :  $-40^{\circ}\text{C}$  to  $+80^{\circ}\text{C}$ .
- i. Humidity (non-condensing)  $95\% \text{RH}$ .

**BELKIN®**

BELKIN CORPORATION  
501 West Walnut Street, Compton, CA 90220-5221, USA  
TEL: 310-898-1100; FAX: 310-898-1111  
www.belkin.com

PART NO.: F2F80200

DES.: ST to ST Duplex patch cord

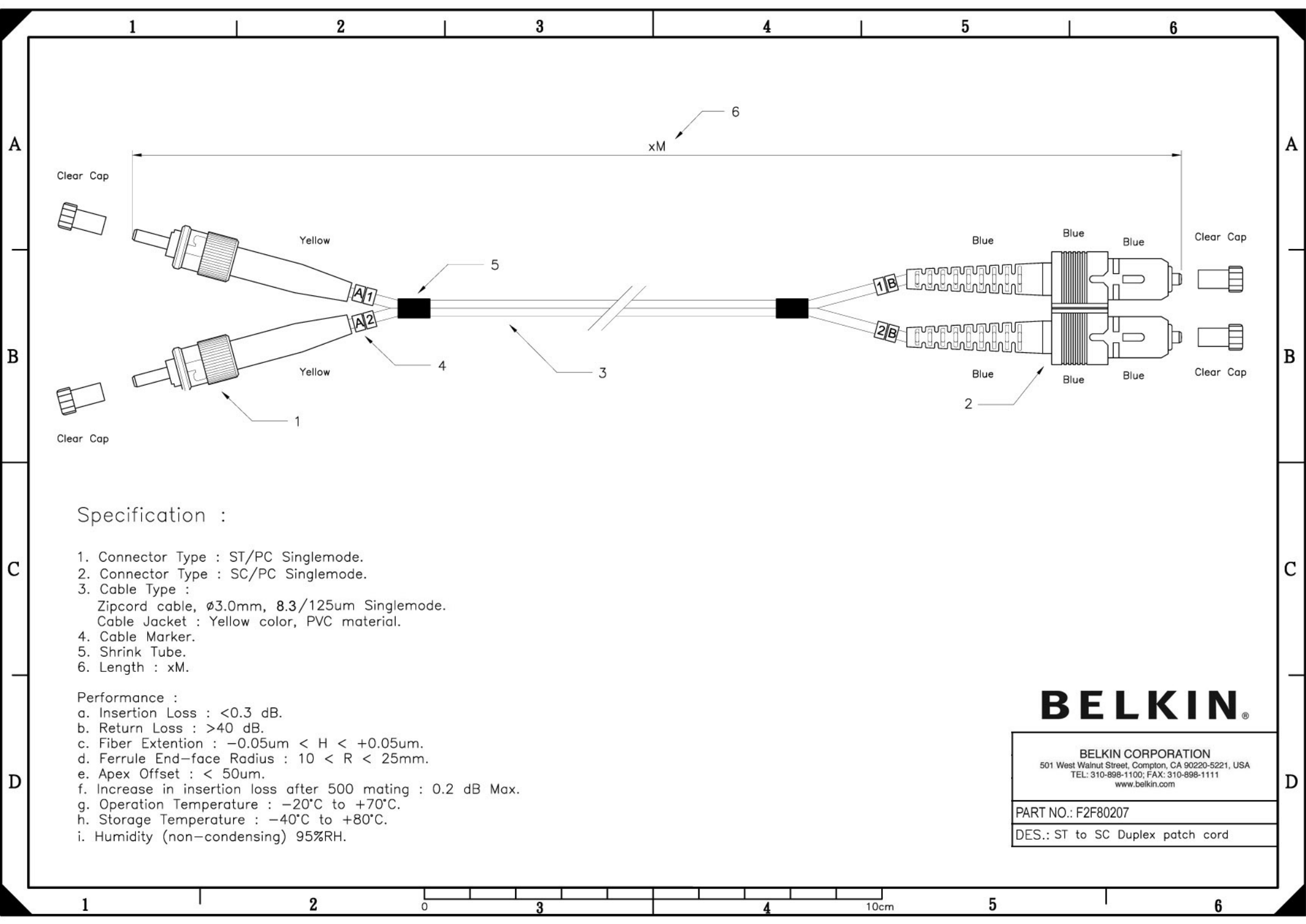

Specification :

1. Connector Type : ST/PC Singlemode.
2. Connector Type : SC/PC Singlemode.
3. Cable Type :  
Zipcord cable,  $\varnothing 3.0\text{mm}$ ,  $8.3/125\mu\text{m}$  Singlemode.  
Cable Jacket : Yellow color, PVC material.
4. Cable Marker.
5. Shrink Tube.
6. Length : xM.

Performance :

- a. Insertion Loss :  $< 0.3 \text{ dB}$ .
- b. Return Loss :  $> 40 \text{ dB}$ .
- c. Fiber Extention :  $-0.05\mu\text{m} < H < +0.05\mu\text{m}$ .
- d. Ferrule End-face Radius :  $10 < R < 25\text{mm}$ .
- e. Apex Offset :  $< 50\mu\text{m}$ .
- f. Increase in insertion loss after 500 mating :  $0.2 \text{ dB Max}$ .
- g. Operation Temperature :  $-20^{\circ}\text{C}$  to  $+70^{\circ}\text{C}$ .
- h. Storage Temperature :  $-40^{\circ}\text{C}$  to  $+80^{\circ}\text{C}$ .
- i. Humidity (non-condensing)  $95\% \text{RH}$ .

**BELKIN®**

BELKIN CORPORATION  
501 West Walnut Street, Compton, CA 90220-5221, USA  
TEL: 310-898-1100; FAX: 310-898-1111  
www.belkin.com

PART NO.: F2F80207

DES.: ST to SC Duplex patch cord

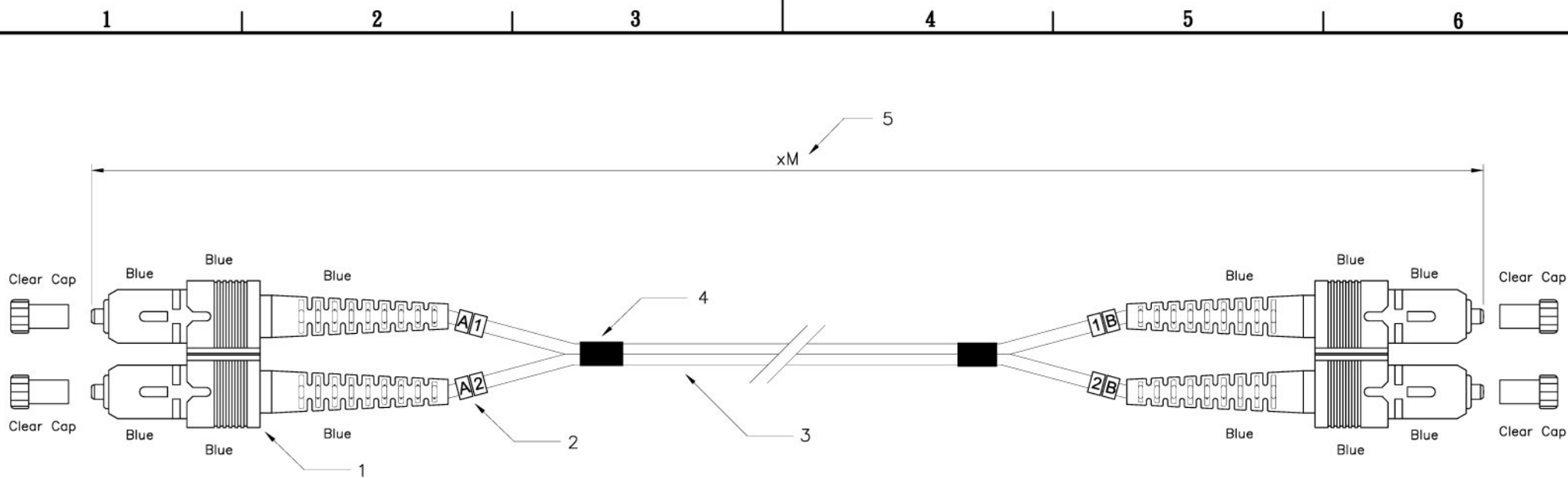

Specification :

1. Connector Type : SC/PC Singlemode.
2. Cable Marker.
3. Cable Type :  
Zipcord cable,  $\varnothing 3.0\text{mm}$ , 8.3/125um Singlemode.  
Cable Jacket : Yellow color, PVC material.
4. Shrink Tube.
5. Length : xM.

Performance :

- a. Insertion Loss :  $< 0.3 \text{ dB}$ .
- b. Return Loss :  $> 40 \text{ dB}$ .
- c. Fiber Extension :  $-0.05\mu\text{m} < H < +0.05\mu\text{m}$ .
- d. Ferrule End-face Radius :  $10 < R < 25\text{mm}$ .
- e. Apex Offset :  $< 50\mu\text{m}$ .
- f. Increase in insertion loss after 500 mating :  $0.2 \text{ dB Max}$ .
- g. Operation Temperature :  $-20^{\circ}\text{C}$  to  $+70^{\circ}\text{C}$ .
- h. Storage Temperature :  $-40^{\circ}\text{C}$  to  $+80^{\circ}\text{C}$ .
- i. Humidity (non-condensing) 95%RH.

**BELKIN®**

BELKIN CORPORATION  
501 West Walnut Street, Compton, CA 90220-5221, USA  
TEL: 310-898-1100; FAX: 310-898-1111  
www.belkin.com

PART NO.: F2F80277

DES.: SC to SC Duplex patch cord